



Planning Director Staff Report Hearing on August 4, 2022

County of Ventura • Resource Management Agency

800 S. Victoria Avenue, Ventura, CA 93009 • (805) 654-2478 • www.vcrma.org/divisions/planning

DOBERMAN PINSCHER RESCUE MODIFICATION OF CONDITIONAL USE PERMIT (CUP) LU05-0008, CASE NO. PL20-0140

A. PROJECT INFORMATION

1. **Request:** The applicant requests approval of a Minor Modification of Conditional Use Permit (CUP) LU05-0008 to authorize the continuation of an animal keeping (non-husbandry) and kennel facility for an additional 10-year period (Case No. PL20-0140).
2. **Applicant/Property Owner:** Ardis Braun, 2946 Young Road, Fillmore, CA 93015
3. **Decision-Making Authority:** Pursuant to the Ventura County Non-Coastal Zoning Ordinance (NCZO) (Section 8105-4 and Section 8111-1.2 et seq.), the Planning Director is the decision-maker for the requested modified CUP.
4. **Project Site Size, Location, and Parcel Number:** The 18.76-acre project site is located at 2946 West Young Road, near the city of Fillmore, in the unincorporated area of Ventura County. The Tax Assessor's parcel number for the parcel that constitutes the project site is 041-0-160-380 (Exhibit 2).
5. **Project Site Land Use and Zoning Designations (Exhibit 2):**
 - a. Countywide General Plan Land Use Map Designation: Agricultural
 - b. Zoning Designation: AE-40 ac (Agricultural Exclusive, 40-acre minimum lot area)
6. **Adjacent Zoning and Land Uses/Development (Exhibit 2):**

Location in Relation to the Project Site	Zoning	Land Uses/Development
North	AE-40 ac	Rural single-family dwelling with agricultural uses (i.e.: citrus and avocado orchards)
East	AE-40 ac	Agricultural uses (i.e.: avocado orchard)
South	AE-40 ac	Agricultural uses (i.e.: citrus and avocado orchards)
West	AE-40 ac	Agricultural uses (i.e.: citrus and avocado orchards)

- 7. History:** On June 21, 1990, the Ventura County Planning Commission approved CUP-4616 for the conversion of a 3,400 square foot residence to a farm worker dwelling unit and the conversion of a 1,750 square foot residence into a storage barn in order to construct a new principal dwelling.

On January 21, 1993, the Ventura County Planning Commission approved Major Modification No. 1 to CUP-4616 to legalize and continue the use of an existing dog kennel for a maximum of 60 dogs. The permit was granted for a seven-year period, ending on June 22, 2007.

On January 24, 1994, the Planning Director approved Major Modification No. 2 to CUP-4616 authorizing an increase in the number of dogs kept at the kennel from 60 to 90 dogs for a one-year period, ending on January 24, 1995. The approval required a condition compliance review, prior to the expiration of the CUP.

On April 4, 1994, the Planning Director approved a permit adjustment to CUP-4616 authorizing four kennels for larger dogs. The maximum number of dogs allowed for the kennel remained unchanged at 90 dogs.

On January 24, 1995, CUP-4616 expired due to the applicant's failure to timely request a condition compliance review and renew the permit.

On June 19, 2000, the applicant submitted an application for Major Modification No. 3 to CUP-4616. This request was to reinstate the expired permit and to increase the number of dogs from 90 to 120 dogs. On March 20, 2002, the Planning Director terminated this requested Major Modification to CUP-4616 due to failure to provide the information and materials that were required in order to complete the application.

On July 27, 2004, the County Planning Division issued Zoning Violation No. ZV04-0156 to Ardis Braun-Munck, the kennel operator/property owner, for operating the dog kennel without a valid CUP.

On January 19, 2005, the applicant submitted an application for a new CUP (Case No. LU05-0008) to abate Zoning Violation No. ZV04-0156 and allow the operation of a kennel for 150 dogs. CUP LU05-0008 was approved by the Planning Director on January 4, 2011, for a 10-year period.

On April 29, 2011, the Planning Manager ministerially authorized a 90-day time extension to obtain a Zoning Clearance for use inauguration to effectuate CUP LU05-0008. The new deadline to obtain the Zoning Clearance was changed to July 29, 2011.

On January 8, 2021, the Planning Division accepted the subject application (Case No. PL20-0140) requesting a modification of CUP LU05-0008 to authorize a permit

extension for an additional 10-year period and minor changes to the facility. On January 20, 2022, County Planning staff deemed the subject application complete for processing.

8. Project Description: The applicant requests that a Minor Modification of CUP LU05-0008 be granted to authorize the continuation of an animal keeping (non-husbandry) and kennel facility for an additional 10-year period. The applicant also requests authorization to make the following changes at the facility within the existing CUP boundary:

- Install a six-foot to eight-foot-high decorative concrete block wall along the entire northern perimeter of the project site (approximately, 240 feet), with the exception of the existing driveway, satisfying the minimum requirements as outlined in the Ventura County Agricultural Policy Advisory Committee, *Agricultural/Urban Buffer Policy*;
- Install an approximately 400 square foot concrete slab (impervious area) to allow for additional heavy duty metal wire kennels to be placed atop near the center of the CUP boundary area;
- Install a septic system and tank (below ground) to be connecting to the existing drainage system for the kennels, to capture animal urine and waste runoff from the kennels near the southern boundary of the CUP area. Grading (cut and fill) would not be required to construct the system;
- Remove three sets of existing and abandoned kennels near the western boundary of the CUP area; and,
- Demolish a shed near the western boundary of the CUP area.

No change in the number of dogs at the facility is proposed and the maximum allowance would remain at 150 dogs. The CUP boundary is not proposed to change and would continue to encompass approximately four acres of the overall 18.76-acre project site, with the remainder of the site being used for agricultural purposes.

The facility would continue to employ a total of six persons, plus the facility owner working at the site Monday through Friday from 7:00 a.m. until dusk and volunteers, plus the facility owner to work on Saturday and Sunday from 7:00 a.m. until dusk. The facility would continue to be open to the public on Saturday between the hours of 11:00 a.m. and 3:00 p.m., unless an appointment is made for a weekday viewing of a particular dog. Appointment-only viewing may extend to Sundays, as needed. As previously authorized, the facility would continue to allow for a maximum of 12 cars on the weekend for the public for viewing and dog adoptions, one truck delivery of dog food per week and an on-site port-a-potty for visitors and employees.

Access to the facility remains available from Young Road, a County maintained road, which connects to the entrance driveway on the project site. The site would continue to be provided water service from San Cayetano Mutual Water Company. A private septic system provides sewage disposal for the residential uses on the project site. The project would not involve the removal of avocado, citrus, or oak trees on the project site (Exhibit 3).

B. CALIFORNIA ENVIRONMENTAL QUALITY ACT (CEQA) COMPLIANCE

Pursuant to CEQA (Public Resources Code Section 21000 et seq.) and the CEQA Guidelines (Title 14, California Code of Regulations, Division 6, Chapter 3, Section 15000 et seq.), the proposed project is subject to environmental review.

The State Legislature through the Secretary for Resources has found that certain classes of projects are exempt from CEQA environmental impact review because they do not have a significant effect on the environment. These projects are declared to be categorically exempt from the requirement for the preparation of environmental impact documents. The project includes a request to authorize the continuation of an animal keeping (non-husbandry) and kennel facility for an additional 10-year period, staff has determined that the project qualifies for a Class 1 (Section 15301) categorical exemption. Further, the project will not trigger any of the exceptions to the exemptions listed under CEQA Guidelines Section 15300.2. Therefore, no further environmental review is required.

Therefore, this project is categorically exempt pursuant to Section 15301 of the CEQA Guidelines.

C. CONSISTENCY WITH THE GENERAL PLAN

The proposed project has been analyzed and determined to be consistent with all applicable 2040 Ventura County General Plan policies. A consistency analysis which evaluates the project's consistency with the policies of the General Plan is included as Exhibit 4 of this staff report

D. ZONING ORDINANCE COMPLIANCE

The proposed project is subject to the requirements of the Ventura County NCZO.

Pursuant to the Ventura County NCZO (Section 8105-4), the proposed use is allowed in the Agricultural Exclusive zone district with the granting of a modified CUP. Upon the granting of the modified CUP, the proposed project would comply with this requirement.

The proposed project includes the construction and use of structures that are subject to the development standards of the Ventura County NCZO (Section 8106-1.1). Table 1 lists

the applicable development standards and a description of whether the proposed project complies with the development standards.

Table 1 – Development Standards Consistency Analysis

Type of Requirement	Zoning Ordinance Requirement	Complies?
Minimum Lot Area (Gross)	40 acres	The 18.76-acre lot does not comply with the 40-acre minimum lot area requirement, Nevertheless, according to General Plan Policy LU-4.4 (Nonconforming Parcel Size), the County shall not prohibit the use or development of a parcel which is a legal lot, but which fails to meet the minimum parcel size requirements of the applicable land use designation. Therefore, the lot may be used and developed as proposed.
Maximum Percentage of Building Coverage	Five percent	Yes
Front Setback	20 feet	Yes
Side Setback	10 feet	Yes
Rear Setback	15 feet	Yes
Maximum Building Height	For principal structures, 25 feet (height may be increased above 25 feet to maximum 35 feet if each side yard is at least 15 feet or as specified by permit)	Yes
	For accessory structures, 15 feet (exceptions of Section 8106-7.4 allow for the maximum height to equal the maximum height allowed for the principal structure because a discretionary permit is required)	Yes

E. CUP FINDINGS AND SUPPORTING EVIDENCE

The Planning Director must make certain findings in order to grant a modified CUP, pursuant to Section 8111-1.2.1.1 of the Ventura County NCZO. The ability to make the required findings is evaluated below.

- 1. The proposed development is consistent with the intent and provisions of the County's General Plan and of Division 8, Chapters 1 and 2, of the Ventura County Ordinance Code [Section 8111-1.2.1.1.a].**

Based on the information and analysis presented in Exhibit 4 and Section D of this staff report, the finding that the proposed development is consistent with the intent

and provisions of the County's General Plan and of Division 8, Chapters 1 and 2, of the Ventura County Ordinance Code can be made.

2. The proposed development is compatible with the character of surrounding, legally established development [Section 8111-1.2.1.1.b].

The existing CUP boundary would remain bordered by avocado and citrus orchards to the south, east and west of the project site. A single-family dwelling and additional citrus and avocado orchards are located to the north. Except for the two residences on the project site, there are only three houses within $\frac{3}{4}$ of a mile of the kennels. Additionally, the modified CUP would continue to be subject to conditions of approval with regard to days and hours of operation, nighttime lighting, noise and visitor parking to ensure that the project would continue to be compatible with the character of the surrounding, legally established development (Exhibit 5, Condition of Approval No. 13).

Based on the discussion above, this finding can be made.

3. The proposed development would not be obnoxious or harmful, or impair the utility of neighboring property or uses [Section 8111-1.2.1.1.c].

As discussed in Sections D and E.2 (above) and Exhibit 4 of this staff report, the proposed applicant requests authorization to allow for the continued operation of an animal keeping (non-husbandry) and kennel facility for an additional 10-year period. No adverse effects on neighboring properties or ongoing uses have been identified that would result from implementation of the proposed project.

Based on the discussion above, this finding can be made.

4. The proposed development would not be detrimental to the public interest, health, safety, convenience, or welfare [Section 8111-1.2.1.1.d].

The proposed project would not create any adverse effects on the environment or the use of adjacent properties. Similarly, no effect of the project has been identified that would be detrimental to the public interest, health, safety, or welfare.

Based on the discussion above, this finding can be made.

5. The proposed development, if allowed by a Conditional Use Permit, is compatible with existing and potential land uses in the general area where the development is to be located [Section 8111-1.2.1.1.e].

The existing facility is largely located amongst existing agricultural uses and the location of the facility is not proposed to change. Additionally, conditions of approval (Exhibit 5) would be imposed with the project to ensure that the facility

remains compatible with existing and ongoing uses nearby. No new development is proposed on any of the surrounding parcels.

Based on the discussion above, this finding can be made.

6. The proposed development will occur on a legal lot [Section 8111-1.2.1.f].

According to a Preliminary Legal Lot Determination, dated October 20, 1988, the subject project site was legally created as a remainder of a lot created by deed, recorded on May 19, 1927 (Book 148, Page 136 of Official Records) after the portion of conveyed by deed, recorded on March 5, 1957 (Book 1489, Page 243 of Official Records). The lot was created prior to the regulation by the State Subdivision Map Act and the Ventura County Subdivision Ordinance.

Based on the discussion above, this finding can be made.

7. The proposed development is approved in accordance with the California Environmental Quality Act and all other applicable laws.

The project was reviewed by multiple County of Ventura agencies. Pursuant to the CEQA Guidelines and through careful analysis, the project was determined to qualify for a categorical exemption (Class 1, Section 15301). Additionally, staff has determined that none of the exceptions to the exemptions listed in CEQA Guidelines Section 15300.2 would apply.

Based on the discussion above, this finding can be made.

8. The establishment or maintenance of this use will not significantly reduce, restrict or adversely affect agricultural resources or the viability of agricultural operations in the area [Section 8111-1.2.1.2.a].

As discussed in Section D and Exhibit 4 of this staff report, staff has determined that the establishment and continued maintenance of the existing use would not significantly reduce, restrict or adversely affect agricultural resources or the viability of agricultural operations in the area.

Based on the discussion above, this finding can be made.

9. The structures will be sited to minimize conflicts with agriculture, and other uses will not significantly reduce, restrict or adversely affect agricultural activities on-site or in the area, where applicable [Section 8111-1.2.1.2.b].

As discussed in Section D and Exhibit 4 of this staff report, staff has determined that structures would continue to be sited to minimize conflicts with agriculture, and that on-going other uses would not significantly reduce, restrict or adversely affect agricultural activities on-site or in the area, where applicable.

Based on the discussion above, this finding can be made.

10. The use will be sited to remove as little land from agricultural production (or potential agricultural production) as possible [Section 8111-1.2.1.2.c].

As discussed in Section A (above), the facility is existing with no proposed change in siting, and therefore, no agricultural land would be removed by the implementation of the project.

Based on the discussion above, this finding can be made.

F. PLANNING DIRECTOR HEARING NOTICE, PUBLIC COMMENTS, AND JURISDICTIONAL COMMENTS

The Planning Division provided public notice regarding the Planning Director hearing in accordance with the Government Code (Section 65091), Ventura County NCZO (Section 8111-3.1). On July 7, 2022, the Planning Division mailed notice to owners of property within 2,500 feet of the property on which the project site is located. The Planning Division's request for a legal ad in the Ventura County Star was not fulfilled and the Planning Director hearing will be continued to August 4, 2022.

The project site is located within the City of Fillmore's Area of Interest. Therefore, on January 12, 2021, the Planning Division notified the City of Fillmore of the proposed project and requested the City of Fillmore to submit any comments that the City might have on the proposed project. As of the date of this staff report, no comments from the City of Fillmore have been received.

G. RECOMMENDED ACTIONS

Based upon the analysis and information provided above, Planning Division Staff recommends that the Planning Director take the following actions:

1. **CERTIFY** that the Planning Director has reviewed and considered this staff report and all exhibits thereto, and has considered all comments received during the public comment process;
2. **FIND** that this project is categorically exempt from CEQA pursuant to Section 15301 of the CEQA Guidelines;
3. **MAKE** the required findings to grant a Minor Modification of CUP LU05-0008, pursuant to Section 8111-1.2.1.1 of the Ventura County NCZO, based on the substantial evidence presented in Section E of this staff report and the entire record;
4. **GRANT** Modified CUP, Case No. PL20-0140, subject to the conditions of approval (Exhibit 5); and,

5. **SPECIFY** that the Clerk of the Planning Division is the custodian, and 800 S. Victoria Avenue, Ventura, CA 93009 is the location, of the documents and materials that constitute the record of proceedings upon which this decision is based.

The decision of the Planning Director is final unless appealed to the Planning Commission within 10 calendar days after the permit has been approved, conditionally approved, or denied (or on the following workday if the 10th day falls on a weekend or holiday). Any aggrieved person may file an appeal of the decision with the Planning Division. The Planning Division shall then set a hearing date before the Planning Commission to review the matter at the earliest convenient date.

If you have any questions concerning the information presented above, please contact John Kessler at (805) 654-2461 or john.kessler@ventura.org.

Prepared by:



John Kessler, Case Planner
Commercial & Industrial Permits Section
Ventura County Planning Division

Reviewed by:



Mindy Fogg, Planning Manager
Commercial & Industrial Permits Section
Ventura County Planning Division

EXHIBITS

- Exhibit 2 Maps
- Exhibit 3 Project Plans
- Exhibit 4 General Plan Consistency Analysis
- Exhibit 5 Conditions of Approval



site

Sources: Esri, HERE, Garmin, USGS, Intermap, INCREMENT P, NRCan, Esri Japan, METI, Esri China (Hong Kong), Esri Korea, Esri (Thailand), NGCC, © OpenStreetMap contributors, and the GIS User Community



Ventura County, California
Resource Management Agency
GIS Development & Mapping Services
Map created on 06-13-2022



County of Ventura
Planning Director Hearing
PL20-0140
Exhibit 2 - Maps

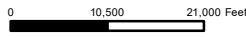

Disclaimer: This Map was created by the Ventura County Resource Management Agency, Mapping Services - GIS which is designed and operated solely for the convenience of the County and related public agencies. The County does not warrant the accuracy of this map nor does it involve a risk of economic loss or physical injury should be made in reliance thereon.



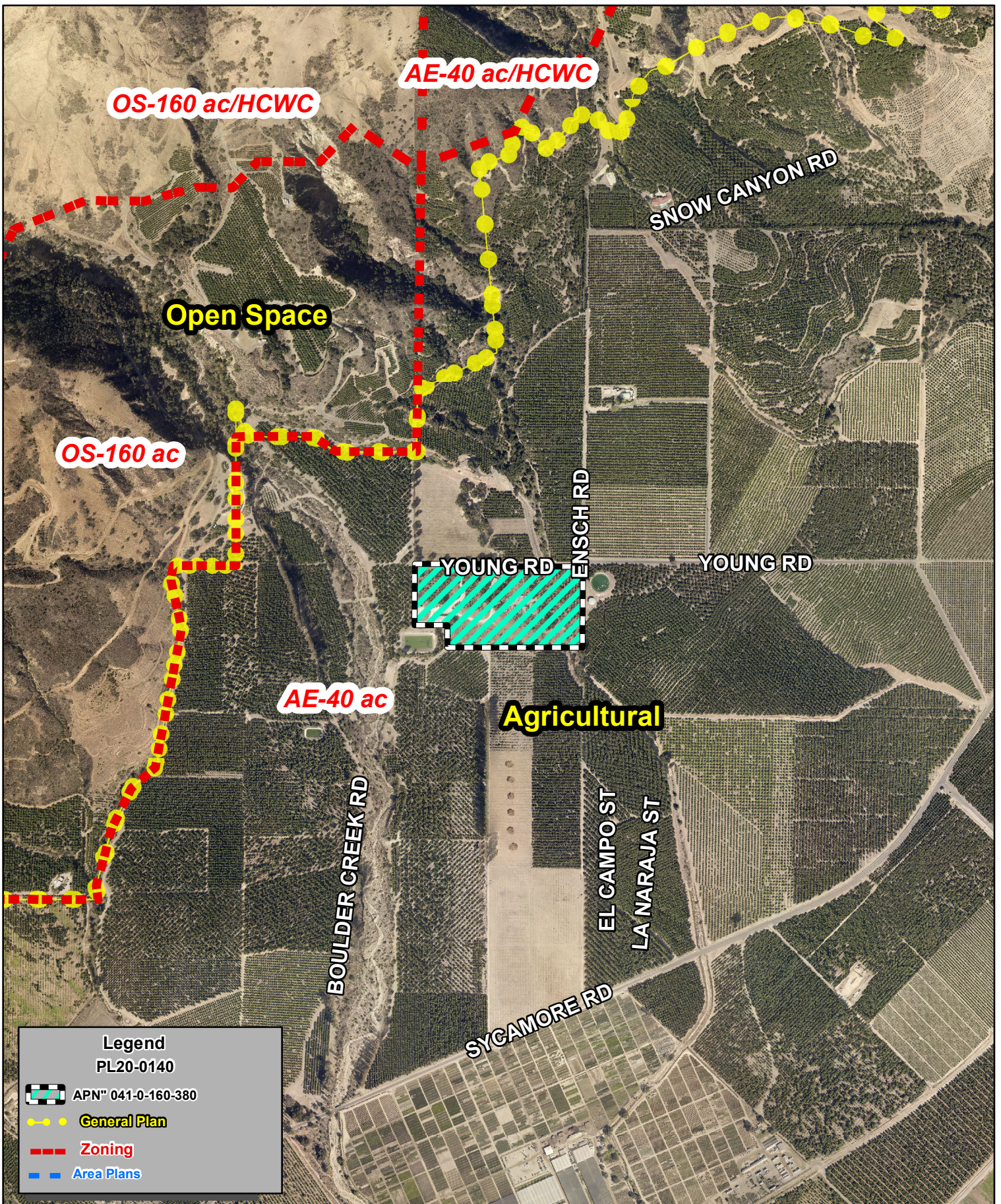

Ventura County, California
 Resource Management Agency
 GIS Development & Mapping Services
 Map Created on 06-13-2022
 This aerial imagery is under the
 copyrights of Pictometry
 Source: Pictometry, 2019



County of Ventura
 Planning Director Hearing
 PL20-0140
 General Plan & Zoning Map

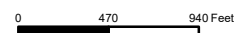

Disclaimer: This Map was created by the Ventura County Resource Management Agency, Mapping Services - GIS which is designed and operated solely for the convenience of the County and related public agencies. The County does no warrant the accuracy of this map and no decision involving a risk of economic loss or physical injury should be made in reliance thereon.





Ventura County, California
Resource Management Agency
GIS Development & Mapping Services
Map Created on 06-13-2022
This aerial imagery is under the
copyrights of Vexcel 2020



County of Ventura
Planning Director Hearing
PL20-0140
Aerial Photography

0150 Feet
E

Disclaimer: This Map was created by the Ventura County Resource Management Agency, Mapping Services - GIS which is designed and operated solely for the convenience of the County and related public agencies. The County does not warrant the accuracy of this map and no decision involving a risk of economic loss or physical injury should be made in reliance thereon.



EAST BOUNDARY

Photo #4
existing pepper tree

PROJECT PERIMETER FENCE

Photo #3
existing oak

• = vegetative barrier
plant:
mountain laurel
ficus
lemonade berry

Photo #2
existing bush

DRIVEWAY
14' AT NARROWEST POINT

PROJECT PERIMETER FENCE

Photo #1
Pepper tree
Existing

THIS TOPOGRAPHY WAS COMPILED FROM AN EXISTING ACCESS ROAD PLAN SUPPLIED BY THE CLIENT AND VERIFYING DATA BY A FIELD VISIT.

UNDERGROUND SERVICE ALERT



CALL TOLL FREE
1-800-227-2600
TWO WORKING DAYS BEFORE YOU DIG

KENNEL OCCUPANCY

5'W x 10'L x 6'H = ONE LARGE DOG
OR TWO SMALL DOGS
5'W x 15'L x 6'H = TWO LARGE DOGS
OR FOUR SMALL DOGS

PREPARED BY: FRED W. HAMMAR
P.O. BOX 162
SOMIS, CA 93066
(805)491-0294



County of Ventura
Planning Director Hearing
PL20-0140
Exhibit 3 - Project Plans

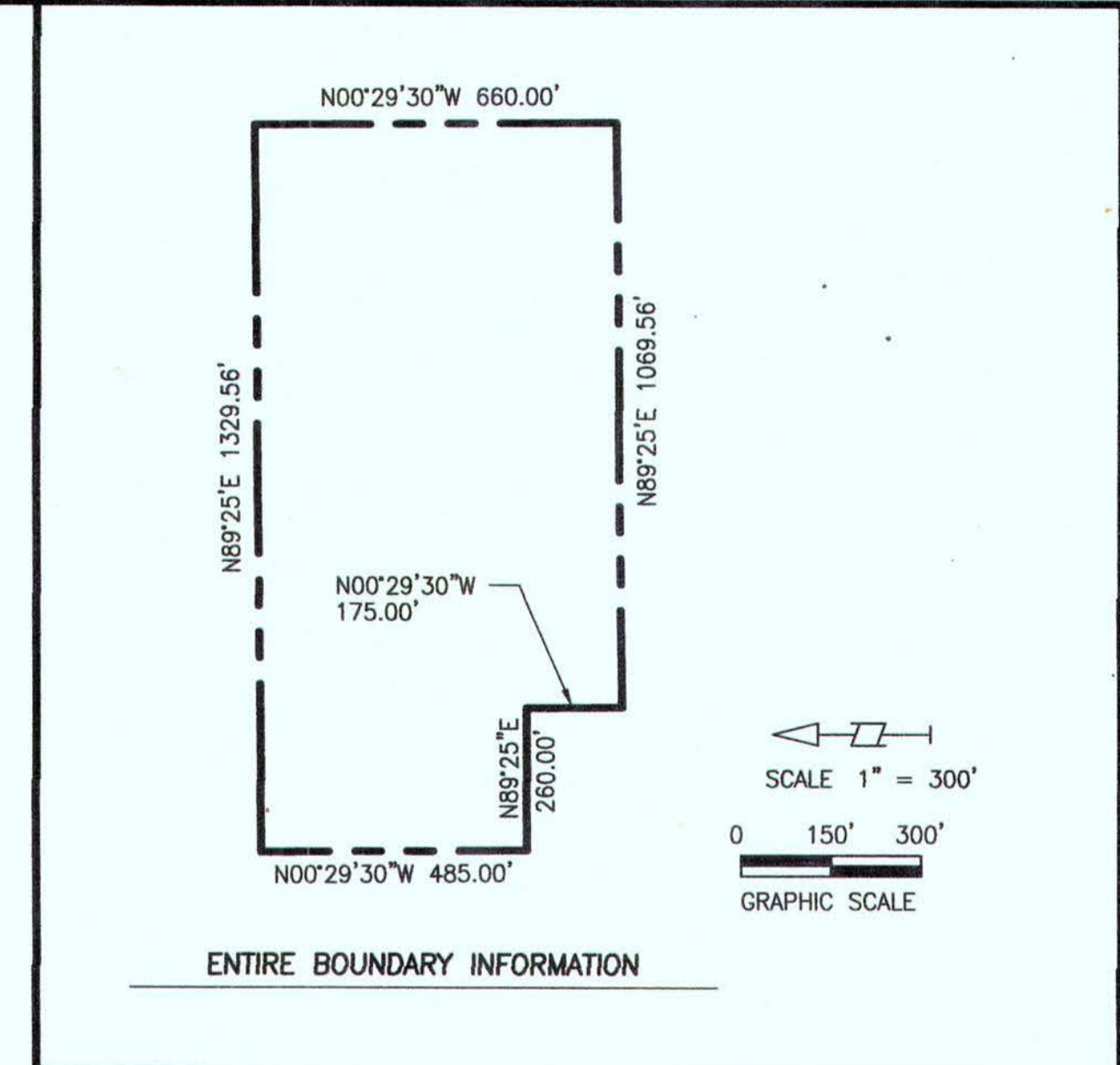

CONSTRUCTION NOTES

- INSTALL 12" x 12" PRECAST CONCRETE GRATED INLET PER PRECON PRODUCTS CB1212 OR APPROVED EQUAL.
- INSTALL 8" PVC OR ABS DRAINAGE PIPE, SEE PLAN FOR LENGTH AND SLOPE.
- INSTALL 50% OF 6" PERFORATED P.V.C. OR ABS PIPE FOR INFILTRATION LINE.
- INSTALL 2' x 2' GRATED CATCH BASIN W/UNITED PUMPING SERVICE DRAIN-PAC FOR FILTRATION. SEE CATCH BASIN DETAIL HEREON.
- INSTALL 50% OF 8" PERFORATED PIPE.
- EX. EARTHEN SWALE TO REMAIN OR REMOVE AND REPLACE WITH CONCRETE SWALE AS APPROVED BY VENTURA COUNTY PUBLIC WORKS. SEE CONCRETE SWALE DETAIL HEREON.
- CONSTRUCT EARTHEN SWALE PER DETAIL HEREON.
- INSTALL 8" PVC OR ABS 45° ELL.
- CONSTRUCT 6" THICK CONCRETE PAD, W/8x8 10x10 W/M FOR NEW KENNEL. SEE PLAN FOR LENGTH AND WIDTH.
- INSTALL 8" CLEAN-OUT.

NOTE:
ALL ELEVATIONS TO BE VERIFIED
PRIOR TO CONSTRUCTION.

concrete for
new proposed
kennels

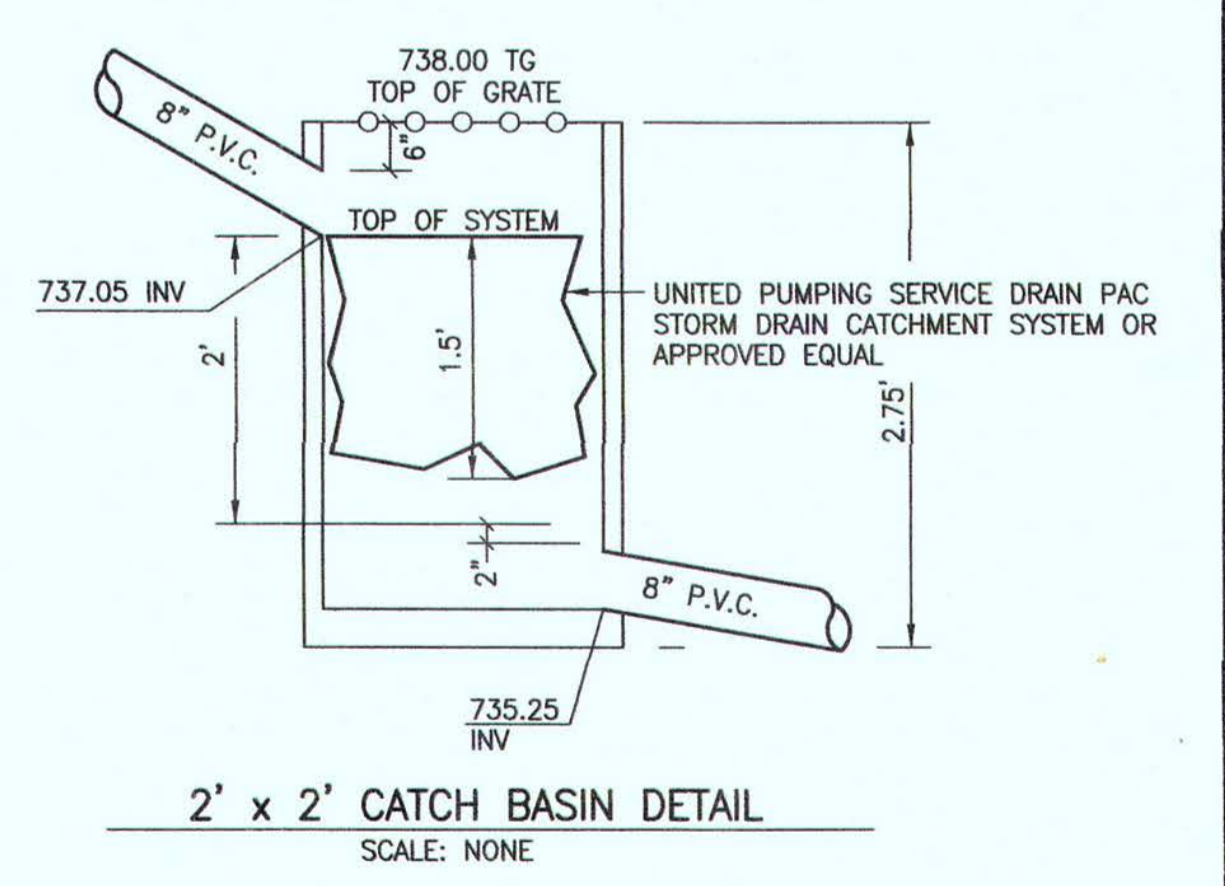

MAP LEGEND

T.C.	TOP OF CURB	T.O.D.	TOP OF DITCH
F.L.	FLOWLINE	G.B.	GRADE BREAK
B.C.R.	BEGIN CURB RETURN	B.L.	BOUNDARY LINE
E.C.R.	END CURB RETURN	TG	TOP OF GRATE
T.W.	TOP OF WALL	C.F.	CURB FACE
B.W.	BOTTOM OF WALL	F.F.	FINISHED FLOOR
EX.	EXISTING	LF	LINEAR FEET
CL	CENTERLINE	M.H.	MANHOLE
DL	DAYLIGHT LINE	W.S.	WATER SURFACE
R/W	RIGHT-OF-WAY	C.O.D.	CITY OF OXNARD
C	CUT	P.S.	PARKING SPACE
F	FILL	A.P.W.A.	AMERICAN PUBLIC WORKS ASSOCIATION
TOE	TOE OF SLOPE	FDC	FIRE DEPARTMENT CONNECTION
TOP	TOP OF SLOPE	R.L.	RIDGE LINE
S.L.	STREET LIGHT	P.O.C.	POINT OF CONNECTION
L.A.	LANDSCAPE AREA	P	PROPERTY LINE
		T.E.	TRASH ENCLOSURE

SITE PLAN: RECONFIGURED
LU 05-0008
2946 YOUNG ROAD, FILLMORE CA JUNE, 2021

A.P. 041-0-160-310

C:\ARDS BRAUN\ARDS-SITE REV 2.DWG DATE: 01-07-11

YOUNG ROAD

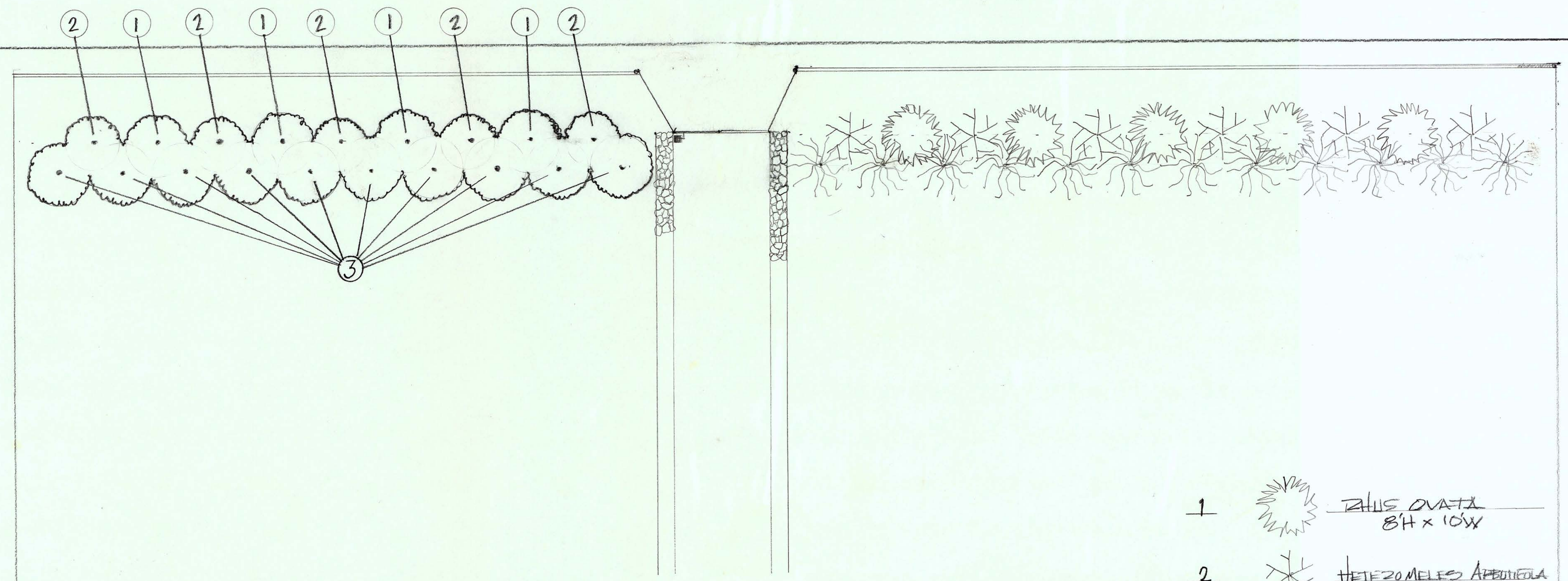

- 1  ILEX OVATA
8'H x 10'W
- 2  HETEROMELES APPROPINQUATA
10'H x 10'W
- 3  MADROA LAURILLA
18'H x 13'W

SCALE
1" = 10'-0"

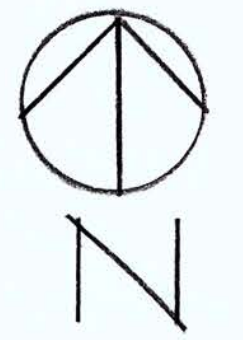

DOBERMAN PESQUE
VEGETATIVE BARRIER
PRELIMINARY PLAN
JUNE 25, 2021

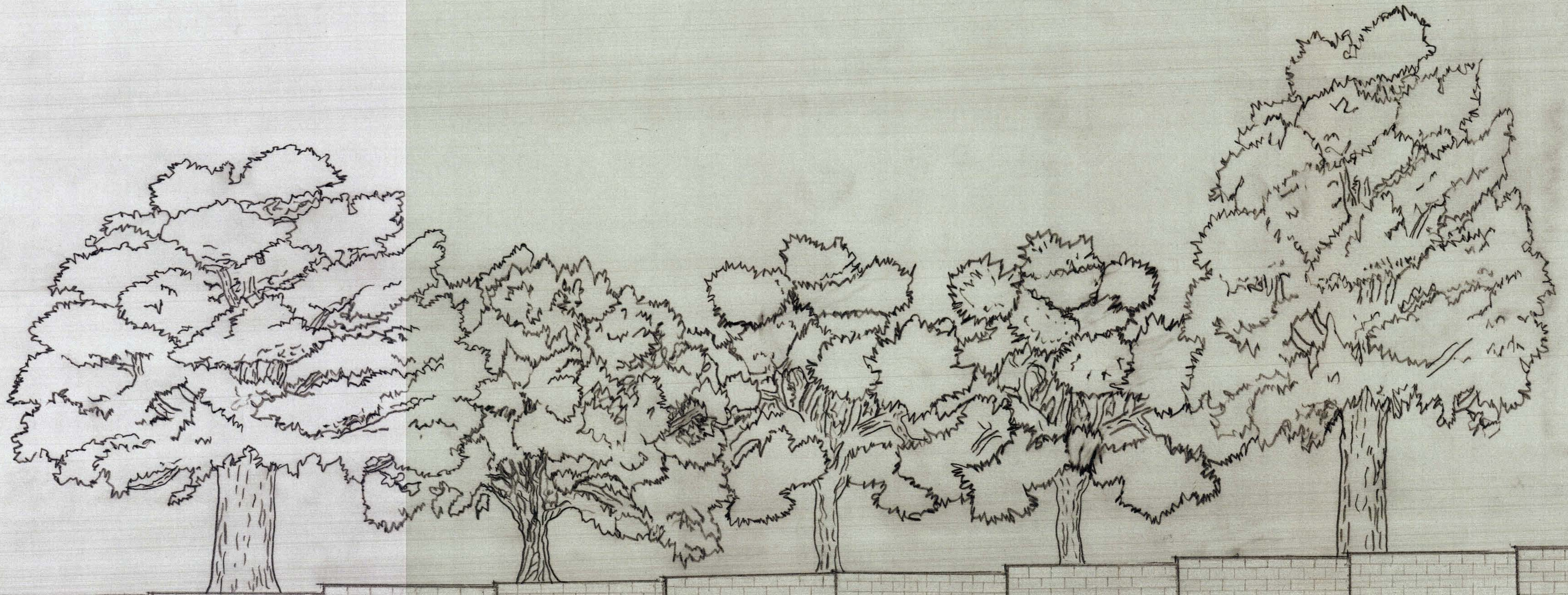

YOUNG RD.

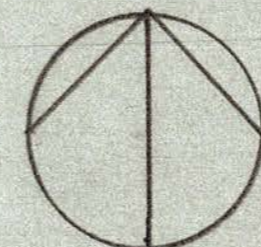

SOUTH

1/4" = 1'-0"

DOBERMAN RESCUE 2946 YOUNG RD. FILLMORE CA 93015
VENTURA COUNTY C.U.P. PROPOSED CONCRETE STONE WALL / SCREEN

8/1/25
FES



Exhibit 4 - General Plan Consistency Analysis

County of Ventura • Resource Management Agency • Planning Division

800 S. Victoria Avenue, Ventura, CA 93009-1740 • (805) 654-2478 • vcrma.org/divisions/planning

The 2040 Ventura County General Plan Goals, Policies and Programs (2020, page 1-1) states:

All area plans, specific plans, subdivisions, public works projects, and zoning decisions must be consistent with the direction provided in the County's General Plan.

Furthermore, the Ventura County Non-Coastal Zoning Ordinance (NCZO) Section 81111.2.1.1a.a states that in order to be approved, a project must be found consistent with all applicable policies of the Ventura County General Plan.

This exhibit provides an evaluation of the consistency of the proposed project with the applicable policies of the General Plan Goals, Policies and Programs.

- 1. LU-4.4 Nonconforming Parcel Size:** *The County shall not prohibit the use or development of a parcel which is a legal lot for the purposes of the County Subdivision Ordinance, but which fails to meet the minimum parcel size requirements of the applicable land use designation, solely by reason of such failure. However, this policy shall not be construed to permit the division of any parcel into two or more lots if any of the new lots fail to meet the minimum parcel size requirements.*

The 18.76-acre lot does not comply with the 40-acre minimum lot area requirement of the Agricultural land use designation. Nevertheless, according to General Plan Policy LU-4.4 (Nonconforming Parcel Size), the County shall not prohibit the use or development of a parcel which is a legal lot, but which fails to meet the minimum parcel size requirements of the applicable land use designation. The subject 18.76-acre lot is a legal lot.

Based on the discussion above, the proposed project is consistent with General Plan Policy LU-4.4.

- 2. LU-6.1 Agricultural Buffers:** *The County shall require non-agricultural land uses adjacent to agricultural uses to incorporate adequate buffers (e.g., fences, setbacks) to limit conflicts with adjoining agricultural operations.*

LU-8.2 Land Uses Appropriate for the Agricultural Land Use Designation *The County shall ensure that land designated as Agricultural is used for the production of food, fiber, and ornamentals; animal husbandry and care; uses accessory to*

County of Ventura
Planning Director Hearing
PL20-0140
Exhibit 4 - General Plan Consistency Analysis

agriculture; and limited temporary or public uses which are consistent with agricultural or agriculturally related uses.

The existing animal keeping (non-husbandry) and kennel facility has been in operation since 1993 on a portion of the subject project site (approximately 4 acres). Since 1993, subsequent modifications to the subject CUP have been granted to authorize an increase to the number of dogs and allow placement of additional structures. No physical or operational changes are proposed with the requested modification that would be inconsistent with the agricultural use of the property. In fact, the remainder of the project site that is outside of the CUP boundary would continue to be used for agricultural purposes. Additionally, this modification permit includes a request to authorize construction of a six- to eight-foot-high decorative concrete block wall along the entire northern perimeter of the project site (approximately, 240 feet), with the exception of the existing driveway. Installation of the block wall would satisfy the minimum requirements as outlined in the Ventura County Agricultural Policy Advisory Committee (VCAPAC), Agricultural/Urban Buffer Policy.

Based on the discussion above, the proposed project is consistent with General Plan Policies LU-6.1 and LU-8.2.

- 3. LU-16.1 Community Character and Quality of Life:** *The County shall encourage discretionary development to be designed to maintain the distinctive character of unincorporated communities, to ensure adequate provision of public facilities and services, and to be compatible with neighboring uses.*

The ongoing presence and use of the existing animal keeping and kennel facility would not result in any new effect on public views from Young Road or any other public viewpoint, with the exception of a new decorative concrete block wall. As stated in above, the block wall is required to satisfy the minimum requirements in the VCAPAC Agricultural/Urban Buffer Policy. No other new effect on community character would result from the project as no other physical or operational changes in the existing facilities are proposed.

Adequate public services (water, sewer, road access) would continue to be available to serve the subject facility.

Based on the discussion above, the proposed project is consistent with General Plan Policy LU-16.1.

- 4. PFS-1.7 Public Facilities, Services, and Infrastructure Availability:** *The County shall only approve discretionary development in locations where adequate*

public facilities, services, and infrastructure are available and functional, under physical construction, or will be available prior to occupancy.

PFS-4.2 Onsite Wastewater Treatment Systems: *The County may allow the use of onsite wastewater treatment systems that meet the state Water Resources Control Board Onsite Wastewater Treatment System Policy, Ventura County Sewer Policy, Ventura County Building Code, and other applicable County standards and requirements.*

PFS-12.3 Adequate Water Supply, Access, and Response Times for Firefighting Purposes: *The County shall prohibit discretionary development in areas that lack and cannot provide adequate water supplies, access, and response times for firefighting purposes.*

WR-1.11 Adequate Water for Discretionary Development: *The County shall require all discretionary development to demonstrate an adequate long-term supply of water.*

Adequate access and public services would continue to be available to serve the subject facility. Water would continue to be provided by the United Water Conservation District. Wastewater treatment would continue to be provided by an existing onsite wastewater treatment facility (septic). Fire suppression measures are incorporated into the design of the existing facility.

Based on the discussion above, the proposed project is consistent with General Plan Policies PFS-1.7, PFS-4.2, PFS-12.3, and WR-1.11.

- 5. PFS-3.2 Fair Share of Improvement Costs:** *The County shall require development to pay its fair share of community improvement costs through impact fees, assessment districts, and other mechanisms.*

The applicant would be required by Condition of Approval No. 46 to pay a Traffic Impact Mitigation Fee (TIMF) in accordance with County policy to address the contribution of the project to regional traffic congestion.

Based on the discussion above, the proposed project is consistent with General Plan Policies PFS-3.2.

- 6. PFS-11.4 Emergency Vehicles Access:** *The County shall require all discretionary development to provide, and existing development to maintain, adequate access for emergency vehicles, including two points of access for subdivisions and multifamily developments.*

The existing facility includes a single 14-foot-wide driveway connected to Young Road. This accessway would continue to provide adequate access through the project site and facilities for emergency vehicles. A second point of ingress/egress exists at the western side of the CUP boundary. The Ventura County Fire Protection District reviewed the requested project and is recommending to carry forward all previous conditions of approval that were originally granted with the initial CUP.

Based on the discussion above, the proposed project is consistent with General Plan Policies PFS-11.4.

- 7. AG-1.1 Agricultural Land Protection and Preservation:** *The County shall continue to protect and preserve agricultural land by directing growth away from productive agricultural lands into cities, unincorporated urban areas, or existing communities and by supporting the acquisition or voluntary dedication of agriculture conservation easements.*

AG-1.2 Agricultural Land Use Designation: *The County shall ensure that discretionary development located on land designated as Agricultural on the General Plan Land Use Diagram and identified as Prime Farmland or Farmland of Statewide Importance on the State's Important Farmland Inventory is planned and designed to remove as little land as possible from potential agricultural production and to minimize impacts on topsoil.*

AG-2.1 Discretionary Development Adjacent to Agriculturally Designated Lands: *The County shall ensure that discretionary development adjacent to Agriculturally designated lands does not conflict with agricultural use of those lands.*

The proposed project involves the continued operation of an existing animal keeping and kennel facility on an approximately 4-acre portion of the 18.76-acre project site. With the exception of a new decorative concrete block wall to satisfy the minimum requirements in the VCAPAC Agricultural/Urban Buffer Policy, no other physical changes the facility are proposed. In any case, the project site is comprised of both animal keeping and agricultural production. No proposed changes to the agricultural production are proposed.

Based on the above discussion, the proposed project is consistent with policies AG-1.1, AG-1.2 and AG-2.1.

**EXHIBIT 5
DRAFT CONDITIONS OF APPROVAL FOR
CONDITIONAL USE PERMIT (CUP) CASE NO. LU05-0008 (AS MODIFIED BY
MINOR MODIFICATION PERMIT CASE NO. PL20-0140)**

Resource Management Agency Conditions

Planning Division

1. Project Description

This modified Conditional Use Permit (CUP) is based on and limited to compliance with the project description stated in this condition below, Exhibits 2 through 5 of the Planning Director hearing on August 4, 2022, and conditions of approval set forth below. Together, these conditions and documents describe the "Project." Any deviations from the Project must first be reviewed and approved by the County in order to determine if the Project deviations conform to the Project as approved. Project deviations may require Planning Director approval for changes to the permit or further California Environmental Quality Act (CEQA) environmental review, or both. Any Project deviation that is implemented without requisite County review and approval(s) may constitute a violation of the conditions of this permit and applicable law.

The Project description is as follows:

The CUP authorizes the continuation of an animal keeping (non-husbandry) and kennel facility for an additional 10-year period.

The applicant is also authorized to make the following changes at the facility within the existing CUP boundary:

- Install a six-foot to eight-foot-high decorative concrete block wall along the entire northern perimeter of the project site (approximately, 240 feet), with the exception of the existing driveway, satisfying the minimum requirements as outlined in the Ventura County Agricultural Policy Advisory Committee, *Agricultural/Urban Buffer Policy*;
- Install an approximately 400 square foot concrete slab (impervious area) to allow for additional heavy duty metal wire kennels to be placed atop near the center of the CUP boundary area;
- Install a septic system and tank (below ground) to be connecting to the existing drainage system for the kennels, to capture animal urine and waste runoff from the kennels near the southern boundary of the CUP area. Grading (cut and fill) will not be required to construct the system;
- Remove three sets of existing and abandoned kennels near the western boundary of the CUP area (refer to site plan for specific locations); and,

- Demolish a shed near the western boundary of the CUP area.

No change in the number of dogs at the facility is authorized and shall remain at a maximum allowance of 150 dogs. The CUP boundary is not authorized to change and shall continue to encompass approximately four acres of the overall 18.76-acre project site, with the remainder of the site being used for agriculture.

The facility shall continue to employ a total of six persons, plus the facility owner working at the site Monday through Friday from 7:00 a.m. until dusk and volunteers, plus the facility owner to work on Saturday and Sunday from 7:00 a.m. until dusk. The facility shall continue to be open to the public on Saturday between the hours of 11:00 a.m. and 3:00 p.m., unless an appointment is made for a weekday viewing of a particular dog. Appointment-only viewing may extend to Sundays, as needed. As previously authorized, the facility shall continue to allow for a maximum of 12 cars on the weekend for the public for viewing and dog adoptions, one truck delivery of dog food per week and an on-site port-a-potty for visitors and employees.

Access to the facility shall remain available from Young Road, a County maintained road, which connects to the entrance driveway on the project site. The site shall continue to be provided water service from San Cayetano Mutual Water Company. A private septic system provides sewage disposal for the residential uses on the project site. The project shall not involve the removal of avocado, citrus, or oak trees on the project site.

The development, use, and maintenance of the property, the size, shape, arrangement, and location of structures, and parking areas, and the protection and preservation of resources shall conform to the project description above and all approved County land use hearing exhibits in support of the Project and conditions of approval below.

2. Acceptance of Conditions and Schedule of Enforcement Responses:

The Permittee's acceptance of this CUP and/or commencement of construction and/or operations under this CUP shall be deemed to be acceptance by the Permittee of all conditions of this CUP. Failure to abide by and faithfully comply with any conditions for the granting of this CUP shall constitute grounds for the implementation of enforcement procedures as provided in the Ventura County Non-Coastal Zoning Ordinance (2010, Article 14), which include, but are not limited to, the following actions:

- Public reporting of violations to the Planning Commission and/or Board of Supervisors;
- Suspension of the permitted land uses (Condition No. 1);
- Modification of the CUP conditions listed herein;
- Recordation of a "Notice of Noncompliance" with the deed to the subject property;
- The imposition of administrative civil penalties; and/or
- Revocation of this CUP.

It is the Permittee's or the Permittee's successors-in-interest's responsibility to be aware of, and to comply with, the CUP conditions and the rules and regulations of all jurisdictions having authority over the uses described herein.

3. Time Limits:

a. Use inauguration:

- (1) The approval decision for this CUP becomes effective upon the expiration of the 10-day appeal period following the approval date on which the Planning Director rendered the decision on the Project, or when any appeals of the decision are finally resolved. Once the approval decision becomes effective, the Permittee must obtain a Zoning Clearance for construction and use inauguration in order to initiate the land uses set forth in Condition No. 1.
- (2) This CUP shall expire and become null and void if the Permittee fails to obtain a Zoning Clearance for construction and use inauguration within one year from the date the approval decision of this CUP becomes effective. The Planning Director may grant a one-year extension of time to the Permittee in order to obtain the Zoning Clearance for construction and use inauguration if the Permittee can demonstrate to the satisfaction of the Planning Director that the Permittee has made a diligent effort to implement the Project, and the Permittee has requested the time extension in writing at least 30 days prior to the one-year expiration date.
- (3) Prior to the issuance of the Zoning Clearance for construction and use inauguration, all fees and charges billed to that date by any County agency, as well as any fines, penalties, and sureties, must be paid in full. After issuance of the Zoning Clearance for construction and use inauguration, any final billed processing fees must be paid within 30 days of the billing date, or the County may revoke this CUP.

b. Permit Life or Operations Period: This CUP will expire on **[insert date]**. The lack of additional notification of the expiration date provided by the County to the Permittee shall not constitute grounds to continue the uses that are authorized by this CUP after the CUP expiration date. The uses authorized by this CUP may continue after the CUP expiration date if:

- (1) The Permittee has filed a permit modification application pursuant to § 8111-6 of the Ventura County Non-Coastal Zoning Ordinance prior to **[insert date]**; and

(2) The County decision-maker grants the requested modification.

The uses authorized by this CUP may continue during processing of a timely-filed modification application in accordance with § 8111-2.10 of the Ventura County Non-Coastal Zoning Ordinance.

4. CUP Modification: Prior to undertaking any operational or construction-related activity which is not expressly described in these conditions or applicable exhibits, the Permittee shall contact the Planning Director to determine if the activity requires a modification of this CUP. The Planning Director may, at the Planning Director's discretion, require that the Permittee file a written and/or mapped description of the proposed activity prior to rendering a decision on whether a CUP modification is required. If a CUP modification is required, the modification shall be subject to:
 - a. The modification approval standards of the Ventura County Ordinance Code in effect at the time the modification application is acted on by the Planning Director; and, Environmental review, as required pursuant to the California Environmental Quality Act (CEQA; California Public Resources Code, §21000-21178) and the State CEQA Guidelines (California Code of Regulations, Title 14, Chapter 3, §15000-15387), as amended from time to time.
5. Consolidation of All Approved Exhibits, Conditions, and Permits: Prior to the issuance of a Zoning Clearance for construction and use inauguration, the Permittee shall provide the following in a form approved by the Planning Director:
 - a. Documentation to verify that all of the requirements of the conditions/programs that are required prior to issuance of a Zoning Clearance have been satisfied; and,
 - b. Documentation to verify that all other entitlements and conditions imposed by any other agencies have been obtained or satisfied.

Within 30 days of any subsequent modifications of a permit or submission of an application for any permit, the applicable materials in revised form shall be submitted to the Planning Director.

6. Notice of CUP Requirements and Retention of CUP Conditions On-Site: Unless otherwise required by the Planning Director, the Owner(s) of record, the contractors, and all other parties and vendors regularly dealing with the daily operation of the proposed activities shall be informed, in writing, by the Permittee of the pertinent conditions of this CUP. A current set of CUP conditions and exhibits shall be retained at the site; the CUP conditions and exhibits shall be provided on-site prior to issuance of a Zoning Clearance for construction and use inauguration shall be maintained on-site until expiration of this CUP.

7. Recorded "Notice of Land Use Entitlement": Prior to the issuance of a Zoning Clearance for construction and use inauguration, and in accordance with the Ventura County Non-Coastal Zoning Ordinance (2010, §8111-8.3), the property owner of record shall sign, have notarized, and record with the Office of the County Recorder, a "Notice of Land Use Entitlement" form furnished by the Planning Division, for each legal parcel within the project site. The "Notice of Land Use Entitlement" is to inform the present and future owners of the property on which the CUP site is located that: the affected real property has been granted a CUP which contains certain conditions for the operation and maintenance of the property; and the purchaser of the real property should be aware of those conditions. A copy of the recorded "Notice of Land Use Entitlement" shall be returned to the Planning Division to be filed with, and made part of, the case file.
8. Condition Compliance, Enforcement, and Other Responsibilities:
 - a. Cost Responsibilities: The Permittee shall bear the full costs of all staff time, materials costs, or consultant costs associated with the approval of studies, generation of studies or reports, on-going permit compliance, and monitoring programs by establishing a revolving compliance account as described below in Condition 9.b. Specifically, the Permittee shall bear the full costs of the following:
 - (1) Condition Compliance, which is defined herein to include, but is not limited to, the staff time, materials costs, or consultant costs associated with the approval of studies, generation of studies or reports, ongoing permit condition compliance review, and CEQA Mitigation Monitoring/other monitoring programs; and,
 - (2) Monitoring and enforcement costs, and any related fines or penalties assessed pursuant to the provisions of the Ventura County Ordinance Code, as it may be amended (Condition 9.c, below).
 - b. Establishment of Revolving Compliance Accounts: Pursuant to the requirements of CUP Case No. LU05-0008, the Resource Management Agency created Condition Compliance Case No. CC11-0001 to cover the costs associated with condition compliance review, monitoring, and enforcement activities, and any duly-imposed civil administrative penalties, regarding CUP Case No. LU05-0008. The Planning Division will continue to use Condition Compliance Case No. CC11-0001 to cover the costs associated with condition compliance review, monitoring, and enforcement activities described in subsection 8.a (above), and any duly-imposed civil administrative penalties regarding this CUP.

Within 10 calendar days of the effective date of the final decision approving this CUP, the Permittee shall submit a new, updated, and completed reimbursement agreement for Condition Compliance Case No. CC11-0001, in a form provided by the Planning Division, obligating the Permittee to pay all condition compliance review, monitoring, and enforcement costs, and any civil administrative penalties, subject to the Permittee's right to challenge all such charges and penalties prior to payment.

- c. Billing Process: The Permittee shall pay all Planning Division invoices within 30 days of receipt thereof. Failure to timely pay an invoice shall subject the Permittee to late fees and charges set forth in the Planning Division Fee Schedule, and shall be grounds for suspension, modification, or revocation of this CUP. The Permittee shall have the right to challenge any charge or penalty prior to payment.

9. Defense and Indemnity:

- a. As a condition of issuance and use of this CUP, including adjustment, modification, or renewal of this CUP, the Permittee agrees to:
 - (1) Defend, at the Permittee's sole expense, any action brought against the County by a third party challenging either its decision to issue this CUP or the manner in which the County is interpreting or enforcing the conditions of this CUP; and,
 - (2) Indemnify the County against any settlements, awards, or judgments, including attorney's fees, arising out of, or resulting from, any such action. Upon demand from the County, the Permittee shall reimburse the County for any court costs and/or attorney's fees which the County may be required by a court to pay as a result of any such action the Permittee defended or had control of the defense of the suit. The County may, at its sole discretion, participate in the defense of any such action, but such participation shall not relieve the Permittee of the Permittee's obligations under this condition.
- b. Neither the issuance of this CUP nor compliance with the conditions thereof shall relieve the Permittee from any responsibility otherwise imposed by law for damage to persons or property, nor shall the issuance of this CUP serve to impose any liability upon the County of Ventura, its officers, or employees for injury or damage to persons or property.
- c. Except with respect to the County's sole negligence or intentional misconduct, the Permittee shall indemnify, defend, and hold harmless the

County, its officers, agents, and employees from any and all claims, demands, costs, and expenses, including attorney's fees, judgments, or liabilities arising out of the construction, maintenance, or operations described in Condition No. 1 (Permitted Land Uses), as it may be subsequently modified pursuant to the conditions of this CUP.

10. Invalidation of Condition(s): If any of the conditions or limitations of this CUP are held to be invalid, that holding shall not invalidate any of the remaining conditions or limitations set forth. In the event that any condition contained herein is determined to be in conflict with any other condition contained herein, then where principles of law do not provide to the contrary, the conditions most protective of public health and safety and natural environmental resources shall prevail to the extent feasible, as determined by the Planning Director.

In the event that any condition imposing a fee, exaction, dedication, or other mitigation measure is challenged by the project sponsors in an action filed in a court of law, or threatened to be filed therein, which action is brought in the time period provided for by the Code of Civil Procedures (§1094.6), or other applicable law, this CUP shall be allowed to continue in force until the expiration of the limitation period applicable to such action, or until final resolution of such action, provided the Permittee has, in the interim, fully complied with the fee, exaction, dedication, or other mitigation measure being challenged.

If any condition is invalidated by a court of law and said invalidation would change the findings and/or the mitigation measures associated with the approval of this CUP, the project may be reviewed, at the discretion of the Planning Director, by the Planning Commission and substitute feasible conditions/mitigation measures may be imposed to adequately address the subject matter of the invalidated condition. The determination of adequacy shall be made by the Planning Commission. If the Planning Commission cannot identify substitute feasible conditions/mitigation measures to replace the invalidated condition and cannot identify overriding considerations for the significant impacts that are not mitigated to a level of insignificance as a result of the invalidation of the condition, then this CUP may be revoked.

11. Consultant Review of Information and Consultant Work: The County and all other permitting agencies shall have the option of referring any and all special studies that may be required by these conditions to an independent and qualified consultant for review and evaluation of issues beyond the expertise or manpower of County staff.

Prior to the County engaging any independent consultants or contractors pursuant to the conditions of this CUP, the County shall confer in writing with the Permittee regarding the necessary work for which to be contracted, as well as the costs of such work. Whenever feasible, the lowest bidder will be used. Any

decisions made by staff may be appealed pursuant to the appeal procedures contained in the Ventura County Zoning Ordinance Code then in effect.

The Permittee may hire private consultants to conduct work required by the County, provided the consultant and the proposed scope-of-work are acceptable to the County. However, the County retains the right to hire its own consultants to evaluate any work undertaken by the operator or consultants under the contract to the operator.

12. Relationship of CUP Conditions, Laws and Other Permits: The design, maintenance, and operation of the CUP area and facilities thereon shall comply with all applicable requirements and enactments of Federal, State, and County authorities, as amended, and all such requirements and enactments shall by reference become conditions of this CUP. In the event of conflicts between various requirements, the more restrictive requirements shall apply. In the event that any CUP condition contained herein is determined to be in conflict with any other CUP condition contained herein, then where principles of law do not provide to the contrary, the CUP condition most protective of public health and safety and environmental resources shall prevail to the extent feasible, as determined by the Planning Director.

No condition of this CUP for uses allowed by the Ventura County Ordinance Code shall be interpreted as permitting or requiring any violation of law, or any lawful rules or regulations or orders of an authorized governmental agency. Neither the issuance of this CUP nor compliance with the conditions of this CUP shall relieve the Permittee from any responsibility otherwise imposed by law for damage to persons or property.

13. Kennel Days and Hours of Operation: The kennel days and hours of operation shall be limited as follows:
- a. Kennel employee work hours shall be limited to Monday through Friday from 7:00 a.m. until dusk, and volunteer work hours shall be limited to Saturday and Sunday from 7:00 a.m. until dusk.
 - b. Public viewing and adoption activities shall be limited to Saturday between the hours of 11:00 a.m. and 3:00 p.m., unless an appointment is made for a weekday or Sunday, or after 3:00 p.m., weekend viewing of a particular dog.

14. Contact Person: (Condition Satisfied)
Prior to the issuance of a Zoning Clearance for construction and use inauguration, the Permittee shall provide the Planning Director with the contact information (e.g., name and/or position title, address, phone number, mailing and email addresses, and business and cell phone numbers) of the Permittee's field

agent and other representatives who receive all orders, notices, and communications regarding matters of condition and code compliance at the CUP site. There always shall be a contact person designated by the Permittee. If deemed necessary by the Planning Director, one contact person shall be available via telecommunication, 24 hours a day, to respond to complaints by citizens and the County. If the address or phone number of the Permittee's agent should change, or the responsibility is assigned to another person or position, the Permittee shall provide the Planning Director with the new information within three calendar days.

15. Reporting of Major Incidents:

The Permittee shall immediately notify the Planning Director by telephone, email, and/or voicemail of any incidents (e.g., fires, explosions, spills, landslides, or slope failures) that could pose a hazard to life or property inside or outside the CUP area. Upon request of any County agency, the Permittee shall provide a written report of any incident within seven calendar days that shall include, but not be limited to, a description of the facts of the incident, the corrective measures used, and the steps taken to prevent a recurrence of the incident.

16. Correspondence from Other Agencies and Jurisdictions: Copies of all correspondence, reports, or information related to land use and environmental issues covered by this CUP which are received by the Permittee from, or sent by the Permittee to, other State or local jurisdictions or agencies shall be provided to the Planning Division within five calendar days of their receipt/issuance.

17. Site Maintenance: The CUP area shall be maintained in a neat and orderly manner so as not to create any hazardous condition, or unsightly conditions which are visible from outside the CUP area on surrounding properties or from any public right-of-way. All equipment and facilities not explicitly permitted in Condition No. 1 (Permitted Land Uses) shall be removed from the site prior to the issuance of a Zoning Clearance for construction and use inauguration. Only equipment, materials, and structures which comply with Condition No. 1 (Permitted Land Uses), or are authorized by any subsequent amendments to this CUP, shall be stored on the property during the life of this CUP.

18. Change of Ownership: At least 10 calendar days prior to the effective date of the change of property ownership, or of lessee(s) or operator(s) of the permitted uses, there shall be filed, as an initial notice with the Planning Director, the new name(s), address(es), telephone/FAX number(s), and email addresses of the new owner(s), lessee(s), operator(s) of the permitted uses, and the company officer(s). A final statement that a transfer of ownership has occurred shall be provided to the Planning Director within 15 calendar days of the transfer. The statement shall include the following:

- a. Any changes in name(s), address(es), telephone number(s), and email addresses of the new owner(s), lessee(s), operator(s) of the permitted uses, and company officer(s) from the initial notice;
- b. A letter from the new property owner(s), lessee(s), and/or operator(s) of the permitted uses acknowledging and agreeing to comply with all conditions of this CUP; and,
- c. The effective date and time of the transfer.

19. Minimizing Nuisance Impacts and Setbacks from Agricultural Uses: The Permittee shall take whatever reasonable steps are necessary, as determined by the Planning Director, to prevent significant nuisance impacts from occurring outside the CUP area. Significant nuisance impacts include, but are not limited to, noise, dust, odors, lighting, and glare. In order to determine the significance of the nuisance, the Planning Director may consider the number and types of neighbor complaints and conduct inspections of the site and surrounding areas. Any questions about what constitutes significant off-site nuisance levels shall be resolved by the Planning Director or other public agency (e.g., the Air Pollution Control District) as the Planning Director may designate.

20. Archaeological and Paleontological Resources: In the event that archaeological or paleontological remains or artifacts are encountered during ground disturbance or construction activities, the Permittee shall implement the following procedures:

- a. If any archaeological or historical artifacts are uncovered during ground disturbance or construction activities, the Permittee shall:
 - (1) Cease operations and assure the preservation of the area in which the discovery was made;
 - (2) Notify the Planning Director in writing, within three days of the discovery;
 - (3) Obtain the services of a County-approved archaeologist who shall assess the find and provide recommendations on the proper disposition of the site; and,
 - (4) Obtain the Planning Director's written concurrence of the recommended disposition before resuming development.
- b. If any human burial remains are encountered during ground disturbance or construction activities, the Permittee shall:
 - (1) Cease operations and assure the preservation of the area in which

- the discovery was made;
- (2) Immediately notify the Sheriff and the Planning Director;
 - (3) Obtain the services of a County-approved archaeologist and, if necessary, Native American Monitor(s), who shall assess the find and provide recommendations on the proper disposition of the site; and,
 - (4) Obtain the Planning Director's written concurrence of the recommended disposition before resuming development on-site.
- c. If any paleontological remains are uncovered during ground disturbance or construction activities, the Permittee shall:
- (1) Cease operations and assure the preservation of the area in which the discovery was made;
 - (2) Notify the Planning Director in writing, within three days of the discovery;
 - (3) Obtain the services of a County-approved paleontologist who shall assess the find and provide recommendations on the proper disposition of the site; and,
 - (4) Obtain the Planning Director's written concurrence of the recommended disposition before resuming development.

Environmental Health Division

21. Existing OWTS – Repair: (New Condition)

Purpose: To demonstrate compliance with State and local regulations related to the design and installation of an onsite wastewater treatment system (OWTS). Only domestic waste as defined in the Ventura County General Plan and the Ventura County Building Code Ordinance is allowed to be discharged into the on-site sewage disposal system.

Requirement: Permittee shall obtain the approval of the Ventura County Environmental Health Division (EHD) to repair/replace the septic tank lids for the existing OWTS. Permittee shall also obtain approval if any other changes, modifications, or repairs to the OWTS are needed, including, but not limited to septic tank replacement, changes to disposal field, adding additional plumbing fixtures and/or adding additional bedroom equivalents.

Documentation: Submit all applicable documentation, including permit application, site plan, bedroom and fixture unit equivalent worksheet, etc., to EHD for review and approval.

Timing: Prior to issuance of a Zoning Clearance for construction and use inauguration, the Permittee shall obtain written confirmation from EHD that the condition has been satisfied.

Monitoring: To assure compliance with this condition, EHD staff shall review and approve the OWTS repair design and permit application, and conduct site inspections during construction.

Ongoing Maintenance: Once the OWTS has been repaired and finalized by EHD, it is the owner's responsibility to properly maintain the system to prevent OWTS failure or an unauthorized sewage release, and from creating a public nuisance, health concern, or impact the environment. The septic tank shall be serviced, as needed, by a septic pumper truck registered and permitted by Ventura County EHD, and all pumping activities shall be reported to EHD. All septage wastes must be disposed of in an approved manner. EHD staff will also receive and respond to any complaints related to OWTS and/or unauthorized sewage releases.

22. Vector Control - Animal Waste & Mosquito Breeding: (New Condition)

Purpose: To ensure site does not contribute to the harborage and/or breeding of potential vectors of disease or create a public nuisance.

Requirement: The storage, handling and disposal of animal wastes shall be in a manner that will not create or promote potential breeding and/or harborage of vectors of disease, such as flies, mosquitoes, and rodents. Ensure animal waste is stored properly and removed as often as needed to prevent fly breeding. Manage standing water onsite, including any stormwater management structures, so it will not create mosquito breeding sources.

Timing: The Permittee shall maintain the Project site so as not to contribute to the harborage and/or breeding of potential vectors of disease, nor the creation of a public nuisance throughout the life of the Project.

Monitoring: Ventura County Environmental Health Division (EHD) staff will receive and respond to vector related complaints at the site. The Division will maintain a record of vector related complaints reported to the Division.

23. Portable Toilets: (New Condition)

Purpose: To ensure the public is provided with toilet facilities which are clean and sanitary, and to prevent a public health concern. To ensure septage from

portable toilets is disposed of in accordance with California Health and Safety Code sections 117400-117450.

Requirement: Septage from portable toilets must be removed by a Ventura County Environmental Health Division (EHD) permitted chemical pumper truck and must be properly disposed of at an approved septage disposal site.

Timing: These requirements apply anytime portable toilets are on the subject property.

Monitoring: EHD staff ensures chemical pumper truck companies are under permit and that septage from portable toilets is properly disposed of at an approved septage disposal site.

Animal Services Department (ASD) Conditions

24. All kennels and its facility shall be kept clean, dry, and free from debris. Kennels must protect against environmental extremes as well as have adequate ventilation and air flow.
25. Indoor kennels must meet the minimum sizes:
 - 3'Wx3'Lx6'H = small to medium dogs
 - 4'Wx4'Lx6'H = large dogs
 - 5'Wx5'Lx6'H = extra large dogs
26. Dogs must have a resting surface 6 inches off the kennel floor.
 - All walls separating kennels shall be 5 feet high.
 - Kennel flooring shall be made of concrete inside and outside. The concrete flooring shall be graded and sealed which allows the water to run off and not create free standing water.
27. Kennel walls must be made or constructed of non-porous material, to allow for easy and effective disinfection. Kennels are to be kept free of debris or material that interferes with proper sanitation. Kennels shall be kept free of any sharp objects or edges that would cause the animal injury.
28. Kennels must be well kept at all times and the Permittee shall complete any repairs within 7-calendar days of notification from ASD or sooner.
29. Outdoor kennel runs that are attached to any indoor kennel must be a minimum of 4' in width, 8' in length, and 6' in height. When having outdoor only kennel(s), the dog must have a dog house or an internal housing box that will allow the dog to be protected from environmental extremes. The minimum requirement for an outside only kennel is 5' in width, 10' in length, and 6' in height.

30. Pre-existing outdoor kennels are acceptable if they meet condition nos. 27, 29 and 30 above. The number of dogs per kennel is based on these minimum sizes:

- 5'Wx10'Lx6'H = 1 large dog or 2 small dogs
- 5'Wx15'Lx6'H = 2 large dogs or 4 small dogs

New outdoor kennels shall be built with wall dividers that start at the floor level.

31. Exercise pens must be at least 10' by 10' in size. The exercise pens must have a shaded area for hot days. All dogs shall have a minimum of 30 minutes of exercise in a pen, or walked, 3 times per week. Puppies shall be exercised twice a day.

32. Any dogs that are placed in a crate must have enough room to stand, sit, lie down and turn about at will. When crating puppies, the maximum amount of time the puppies shall be kept in a crate is as follows:

Puppy Age	Maximum Amount of Time Allowed in a Crate
9 – 10 weeks	60 minutes
11 – 14 weeks	3 hours
15 – 16 weeks	4 hours
17+ weeks	6 hours

33. Pet waste shall be removed at least twice a day and put into an airtight trash type container. The permittee shall arrange to have the solid waste picked up on a weekly basis by a licensed waste hauler.

34. Kitchens or any area surface where food is kept or prepared must be disinfected daily.

35. Dog food must be kept in airtight containers that must be rodent and pest proof.

36. At a minimum, dogs must be fed once per day and 2-3 times per day for puppies. Dogs must have fresh water available at all times.

37. Food bowls must be removed after the dog(s) is finished eating and any left over's need to be thrown away. If daily food bowls are not provided and removed, whatever food is provided for the preceding day that is left over must be discarded, and it must be placed in a bottom feeder.

38. For disinfection, food bowls must be soaked in bleach for a minimum of 10 minutes then washed and air dried. If the Permittee uses a dishwasher, the Permittee shall wash the dishes with dish soap and then put the dishes into the dishwasher.

39. Bedding and blankets must be washed every other day. If the blanket or bedding is soiled it must be removed immediately and a new fresh blanket given to the dog. The Permittee shall add bleach or a bleach alternative to the laundry detergent used to wash blankets.
40. An approved comprehensive disinfecting/sanitizing protocol needs to be established and implemented. Each enclosure must be sanitized daily and disinfected once a week. ASD suggests hypochlorite tablets, such as those offered by Klorman Systems (http://www.klormansystems.com/kennel_plus.htm) for daily sanitation. Weekly deep cleaning should include use of a pressure washer and a properly diluted bleach mixture. Any disinfectant that is used must be non-harmful to animals and used according to the manufactures guidelines for the disinfectant. All sanitation, disinfection and pressure washing is to be completed only when the run is free of animals, and all debris that would preclude actual sanitation/disinfection (i.e. hair, feces, food) is removed.
41. Any new dogs as well as dogs that become sick or injured must be isolated from the general population. All sick or injured dogs must see a vet immediately for proper care.
42. Any and all veterinary records must be available for review at any time during normal business hours.
43. Every dog must be current on all its vaccinations including rabies. Any owned, rescued, or harbored dogs that reside within the county for 30 days on site or longer must follow the state mandated regulation, (California Code of Ordinances Division 2, Chapter 4, Article 6, and Section No. 2591) and purchase a Ventura County dog license.
44. A written fire evacuation plan shall be approved by CVAS and a Knox key for the front gate given to Ventura County Fire Department.

Public Works Agency Conditions

Roads and Transportation Department

45. Traffic Impact Mitigation Fee: (New Condition)

Purpose: To address the cumulative adverse impacts of traffic on the Regional Road Network, Ventura County General Plan Goals, Policies, and Programs CMT-1.7 and Ventura County Ordinance Code, Division 8, Chapter 6 require that the Ventura County Public Works Agency – Roads and Transportation (VCPWA-RT) collect a Traffic Impact Mitigation Fee (TIMF).

Requirement: The applicant/permittee shall deposit with the VCPWA-RT a TIMF. The trip generation rate and TIMF are calculated based on the applicant's information and the project description in the previous CUP. The applicant/permittee may choose to submit additional information or provide a Traffic Study to supplement the information currently provided to establish the trip generation rate. The TIMF may be adjusted for inflation at the time of deposit in accordance with the latest version of the Engineering News Record Construction Cost Index. Based on the applicant's information:

a) The TIMF due to the County of Ventura would be:

$$\$27.38 = 2 \text{ ADT} \times \$13.69^{(2)} / \text{ADT}$$

b) The TIMF due to the City of Fillmore would be:

$$\$127.66 = 2 \text{ ADT} \times \$63.83^{(3)} / \text{ADT}$$

Total Additional Average Daily Trips

$$2 \text{ ADT} = 16 \text{ ADT} - 14 \text{ ADT}$$

Proposed Average Daily Trips

$$16 \text{ ADT}^{(1)} = 15.714 \text{ ADT} = 12 \text{ ADT} + .286 \text{ ADT} + 3.429 \text{ ADT}$$

5 Part-time employees plus the kennel owner

$$6 \text{ vehicles} \times 2 \text{ trips} / \text{vehicles} \times 1 / 1 \text{ day} = 12 \text{ trips} / \text{day} = 12 \text{ ADT}$$

1 truck delivery of food every 1 weeks

$$1 \text{ truck} \times 2 \text{ trips} / \text{truck} \times 1 / 7 \text{ days} = 2 \text{ trips} / 7 \text{ days} = 0.286 \text{ trips} / \text{day}$$

12 vehicles on the weekend for volunteers, public viewing and dog adoptions

$$12 \text{ vehicles} \times 2 \text{ trips} / \text{vehicle} \times 1 / 7 \text{ days} = 24 \text{ trips} / 7 \text{ days} = 3.429 \text{ trips} / \text{day}$$

Existing Average Daily Trips

$$14 \text{ ADT} = 14 \text{ ADT} + 0 \text{ ADT}$$

6 Part-time employees plus the kennel owner

$$7 \text{ vehicles} \times 2 \text{ trips} / \text{vehicles} \times 1 / 1 \text{ day} = 14 \text{ trips} / \text{day} = 14 \text{ ADT}$$

1 truck delivery of food every 5-6 weeks

1 truck x 2 trips / truck x 1 / 35 days = 2 trips / 35 days = 0.057 trips / day = 0 ADT

Notes:

1. The trips generated by the project shall be used as a baseline level so that the TIMF may be computed for future increases in the trip generation. Based on the information in the previous CUP, the existing baseline level is 14 Average Daily Trips (ADT). Based on the information in the application, the proposed baseline level will be 16 ADT.
2. County of Ventura TIMF for the Average Daily Trips in the Fillmore District # 3.
3. The City of Fillmore Reciprocal TIMF for the Average Daily Trips.
4. The TIMF due to the City of Fillmore is to be transferred to the City within 30 calendar days in accordance with the reciprocal traffic mitigation agreement between the City and the County of Ventura.

Documentation: The applicant/permittee shall either come to the VCPWA-RT counter or contact the VCPWA-RT Permits Section by phone at (805) 654-2055 or e-mail at pwa.transpermits@ventura.org, fill out the TIMF form, and pay the TIMF. The applicant/permittee shall provide a copy of the Conditions of Approval for the project. The fee will not be collected without sufficient documentation.

Timing: This condition shall be met prior to the issuance of a Zoning Clearance for construction and use inauguration.

Monitoring and Reporting: The VCPWA-RT will review and approve the payment of the TIMF.

Watershed Protection Division

46. Notice of Flood Hazard Recorded on Property Title: (New Condition)

Purpose: To comply with the *Ventura County General Plan Policy HAZ-2.5* to inform existing and future owners of the subject property that the site, in whole or in part, has currently been mapped by the Federal Emergency Management Agency (FEMA) as being in a Special Flood Hazard Area.

Requirement: The Applicant shall, with the assistance of the Ventura County Public Works Agency Floodplain Manager, have recorded on the title of the subject property a Notice of Flood Hazard.

Documentation: A Notice of Flood Hazard deemed satisfactory to the Ventura County Public Works Agency Floodplain Manager.

Timing: The Notice of Flood Hazard shall be recorded on title of the subject property by the Applicant prior to Zoning Clearance for construction and use inauguration.

Monitoring and Reporting: A copy of the recorded Notice of Flood Hazard shall be provided to the Building and Safety Department as well as maintained in the case file by the Public Works Agency.

Integrated Waste Management Department (IWMD)

47. Commercial Generator: Waste Diversion and Recycling Requirement: (Condition Satisfied)

During the operational phase of this project, the Permittee, as a commercial generator of waste, shall adhere to Section 4770-2 Commercial Customer Waste Diversion Requirements, of the Codified Ordinances of the County of Ventura, which states, in part: "...The Director (Water & Sanitation Department) may develop, maintain, and publish, in consultation with Contract Collectors and other Diversion industry representatives, a 'Directors List of Commercial Recyclables' that shall be subject to the requirements of Section 4770-2.2."

48. Supply and Use of Separate Recyclables Containers for Commercial Customers: (Condition Satisfied)

If the IWMD determines that any materials on the Director's List of Commercial Recyclables (<http://www.wasteless.org/PDF%20files/RecyclablesListBusiness-English.pdf>) are being generated by the project in quantities that justify separate bins for collection and recycling, the Permittee shall ensure that a County approved commercial hauler, or temporary waste collector, provides the required containers for the separated collection of these materials. Please contact Everett King in the IWMD, at (805) 658-4320, for assistance in meeting this condition.

Ventura County Fire Protection District (VCFPD) Conditions

49. On-site Access Road Improvements: (Condition Satisfied)

Access road(s) driveways(s) shall be in accordance with VCFPD access standards. Fifteen feet of all-weather surface shall be provided. Note: The access width may be reduced to 13 feet at the one tree located approximately half way down the main driveway. This improvement shall be made on-site from West Young Road to each dwelling and the garage/ storage structures.

The wire enclosed kennels are exempt from access requirements unless enclosed with solid walls. The access / driveway shall be extended to within 150 feet of all portions of the exterior walls of the first story of any building and shall be in accordance with Fire District access standards. Where the access roadway cannot be provided, approved fire protection system or systems shall be installed as required and acceptable to the Fire District. Provisions for road maintenance shall be made in order to insure continuous access by Fire Department

equipment. On going road maintenance shall be performed as required to maintain the road and at any time as requested by the Fire Department. The access road(s)/driveways(s) shall be certified by a registered civil engineer as having an all weather surface in conformance with Fire District standards. Certification shall be submitted to the Fire District for review and approval prior to Zoning Clearance for construction and use inauguration.

50. Turning Radius: (Condition Satisfied)

The access road shall be of sufficient width to allow for a 40 foot outside turning radius at all turns in the road.

51. Vertical Clearance: (Condition Satisfied)

All access roads/driveways shall have a minimum vertical clearance of 13 feet 6 inches (13' 6").

52. Turnarounds: (Condition Satisfied)

Approved turnaround areas for fire apparatus shall be provided when dead-end VCFPD access roads/driveways exceed 150 feet.

53. Parking Prohibited: (Condition Satisfied)

The property owner(s) are hereby advised that parking on access roads and driveways providing fire department access and within fire department turnaround areas is prohibited

54. Access Road Gates: (Condition Satisfied)

Any gates to control vehicle access are to be located to allow a vehicle waiting for entrance to be completely off the intersecting roadway. A minimum clear open width of 15 feet in each direction shall be provided for separate entry/exit gates and a minimum 20 for combined entry/exit gates. If gates are to be locked, a Knox system shall be installed. The method of gate control, including operation during power failure, shall be subject to review by the VCFPD. Gate plan details shall be submitted to the VCFPD for approval prior to installation. A final acceptance inspection by the VCFPD is required prior to placing any gate into service.

55. Address Numbers: (Condition Satisfied)

Prior to the issuance of a Zoning Clearance for construction and use inauguration, address numbers, a minimum of 6 inches high, shall be installed prior to occupancy, shall be of contrasting color to the background, and shall be readily visible at night. Brass or gold plated numbers shall not be used. Where structures are set back more than 150 feet from the street, larger numbers will be required so that they are distinguishable from the street. In the event a structure(s) is not visible from the street, the address number(s) shall be posted adjacent to the driveway entrance on an elevated post.

56. Hazard Abatement: (Condition Satisfied)

All grass or brush exposing any structure(s) to fire hazards shall be cleared for a distance of 100 feet from any structure and shall be maintained in accordance with VCFPD Ordinance.

57. Fire Department Clearance: (Condition Satisfied)

The Permittee shall obtain VCFPD Form No. 126 "Requirements for Construction" prior to obtaining a building permit for any new structures or additions to existing structures. If the property uses a private water system, submit plans for the private water system along with requirements for construction.

58. Fire Code Permits: (Condition Satisfied)

The Permittee shall obtain all applicable Fire Code (IFC) permits prior to occupancy or use of any system or item requiring an IFC permit.

59. Fire Lanes: (Condition Satisfied)

At the discretion of the VCFPD, all fire lanes shall be posted "NO PARKING-FIRE LANE-TOW AWAY" in accordance with California Vehicle Code, the Uniform Fire Code and current VCFPD Fire Lane Standards. All signs and or Fire Lane markings shall be within recorded access easements.

60. Fire Hydrant Installation: (Condition Satisfied)

A fire hydrant capable of providing the required fire flow and duration shall be installed and in service along the access road / driveway at a location approved by the Fire District, but no further than 250 feet from the building site.

61. Private Water Supply: (Condition Satisfied)

A private water supply shall be installed in accordance with current Fire District requirements. This will require a water storage tank (minimum 5000 gallons) and a fire hydrant. See VCFD Standard 14.5.1.

62. Hydrant Location Markers: (Condition Satisfied)

Prior to occupancy of any structure, blue reflective hydrant location markers shall be placed on the access roads in accordance with Fire District standards.

Ventura County Agricultural Commissioner's Office Conditions:

63. Outdoor activities that generate dust such as vehicles driving into the kennel facility must be halted during high wind events. High wind events are defined as winds of such velocity as to cause fugitive dust to blow from one property to another.

64. All unpaved areas or roadways shall be treated periodically to prevent the spread of dust onto nearby agricultural crops. Treatments may include watering, application of soil stabilizers, roll compaction, or other appropriate treatment.

65. Vegetative Screen: (New Condition)

Purpose: In order to minimize potential conflicts between agricultural operations within 300 feet of the project boundary and the permittee, said permittee must maintain a vegetative screen at the proposed project boundary.

Requirement: The permittee shall install and maintain a vegetative screen meeting the physical characteristics outlined in the Ventura County Agricultural Policy Advisory Committee Agricultural/Urban Buffer Policy.

Documentation: The permittee shall submit to the Ventura County Agricultural Commissioner's Office (VCAC) a landscape plan for the proposed project that includes the required vegetative screen prior to the issuance of the requested CUP.

Timing: Installation of the vegetative screen shall commence prior to the use inauguration of the requested CUP.

Monitoring: The VCAC will report to the Planning Division any reports of failure to comply with this condition.

66. Notification and Response Plan: (New Condition)

Purpose: In order to minimize potential conflicts between agricultural operations within 300 feet of the project boundary and the permittee, said permittee must notify persons associated with the proposed project (associated persons) of agricultural activities within 300 ft of the project boundary.

Requirement: The permittee is required to prepare a Notification and Response Plan, subject to approval by Ventura County Agricultural Commissioner's Office (VCAC). The plan must indicate how associated persons are to be notified that normal farming operations may cause nuisances such as dust or noise, and that the use of fertilizers and/or chemical pest controls may occur in the vicinity. The plan must indicate how associated persons will be instructed to respond in the rare event that adjacent agricultural operations present a hazard to said persons. The permittee is recommended to contact adjacent growers to exchange information about agricultural operations that may be scheduled and make this information available to associated persons.

Documentation: The permittee shall maintain a record that all associated persons notified have received the information outlined in the Notification and Response Plan.

Timing: Prior to the issuance of a Zoning Clearance for construction and use inauguration, the permittee is required to prepare a Notification and Response

Plan, subject to approval by VCAC. Notice shall be provided to associated persons prior to associated persons entering the proposed project boundary.

Monitoring: The permittee shall provide the VCAC with any proposed changes to the Notification and Response Plan for approval. The Ventura County Agricultural Commissioner's Office will keep record of the provided notices and report to the Planning Division any reports of failure to comply with this condition.